



# Low Emission Freight & Logistics Trial (LEFT) Key Findings



**This report is published by the Low Carbon Vehicle Partnership**

Low Carbon Vehicle Partnership  
3 Birdcage Walk,  
London,  
SW1H 9JJ

Tel: +44 (0)20 7304 6880

E-mail: [secretariat@lowcvp.org.uk](mailto:secretariat@lowcvp.org.uk)

**Author:** Brian Robinson CEng CEnv MIMechE FCILT, Commercial Vehicle Emissions Consultant

**Reviewed by:** Andy Eastlake CEng FIMechE, Managing Director, LowCVP

**Date of Report:** November 2020

This report has been prepared by LowCVP to assist in disseminating the key findings of the Low Emission Freight and Logistics Trial (LEFT), which was funded by the **Office for Low Emission Vehicles (OLEV)** and delivered by **Innovate UK**.

On behalf of OLEV and Innovate UK, LowCVP would like to thank all the many dedicated individuals and organisations that have supported, provided additional funding and/or otherwise contributed to the LEFT programme. We are especially grateful to **TRL Ltd** for their management and analyses of the in-service monitoring data and emissions testing, to **Millbrook Proving Ground** for that testing and last, but certainly not least, to all the companies and organisations involved in the individual project trials. There are too many to list them all here but we must acknowledge a particular debt of gratitude to those that directly contributed their time, expertise and learnings from LEFT to the LowCVP dissemination webinars held in July 2020: **Air Liquide, CNG Fuels, Centre for Sustainable Road Freight, Cross River Partnership, GLA, Imperial College London, Menzies Distribution, Tevva Motors, Ulemco and UPS.**



Office for Low Emission  
Vehicles



Innovate  
UK





## Executive Summary

1. Background, objectives, trial methodologies and technologies
2. Revolution Technologies
  - Battery Electric Vehicles
3. Transition Technologies
  - ICE Range Extended Electric Vehicles
  - Spark Ignition Dedicated Gas Vehicles
  - Compression Ignition Gas-Diesel Dual Fuel Vehicles
  - Compression Ignition Hydrogen-Diesel Dual Fuel Vehicles
4. Evolution Technologies
  - Lightweight and Aerodynamic Trailers
  - Trailer Kinetic Energy Recovery System
5. Other LEFT Technologies
6. Summary of trial outcomes
7. Further reading and information

With over £32 million of public and private investment, the LEFT programme supported in-service trials and laboratory-based tests to develop low and zero emission technologies for UK commercial vehicle operators

## Background

- In 2017, **OLEV awarded £20 million of grant funding to the Low Emission Freight & Logistics Trial (LEFT)**, supported by a further **£12 million in private investment** by trial participants, with **Innovate UK** as the delivery partner
- **Eight consortia were funded and completed their trials**, involving various methane, hydrogen combustion, battery (BEV) and range-extended electric vehicles (REEV), aerodynamic and lightweight trailers and a Kinetic Energy Recovery System (KERS)
- **TRL Ltd** were appointed by Innovate UK to manage the test programme and to gather and analyse the in-service data
- **LowCVP** were separately tasked by Innovate UK to oversee and guide all technical aspects of the programme and to summarise its main findings (via two dissemination webinars held in July 2020 and production of this report)

## Programme Objectives

- The overall aims were to support **industry-led trials and encourage the widespread introduction of low and zero emission alternative propulsion technologies** for commercial fleets in the UK
- A further aim was to evaluate each technology through a combination of in-fleet, **in-service monitoring** of their day-to-day, real world impacts and controlled **laboratory-based emissions tests**
- This twin approach allowed the emissions and energy performance of the LEFT technologies, and the practicalities of their in-fleet integration and implementation, to be **compared with equivalent conventional diesel-powered Euro 6/VI vehicles**

## Methodologies

- The **in-service trials required the participating fleet operators to collect data** on the fuel/energy consumption, cost savings, environmental and other notable impacts of their trial vehicles
- The **laboratory emissions tests used LowCVP-derived, industry-recognised standard track and dynamometer duty cycles** appropriate to the vehicle operation; usually City Centre, Urban Delivery, Regional Delivery and Long Haul
- ‘Well to wheel’ (WTW) greenhouse gas emissions were assessed using **UK standard emission factors for ‘grid average’ energy sources and factors estimated for 100% renewable energy sources**, to gauge the likely GHG-reduction potential of widespread adoption of each technology

The technologies trialled can each be placed into one of three broad categories; “Revolution”, “Transition” or “Evolution” technologies, reflecting their decarbonisation and air quality improvement potential

#### Revolution Technologies

- Can, in suitable applications, help make **substantial savings in diesel fuel consumption, energy use, tailpipe and WTW GHG emissions, even using current pump/grid average factors** (typically 50-80% WTW, more if using renewable energy)
- They have **substantial air quality benefits**, over and above Euro VI (zero exhaust emission vehicles)
- In this category, we place the **Battery Electric Vans and HGV**

#### Transition Technologies

- Involve **single-fuel or dual-fuel alternatives to diesel** and, in the right applications with the right fuel production pathways, can help make **moderate savings in GHG emissions** (typically 10-40% with standard “Well to Tank” factors, WTT)
- When combined **with renewable energy sources, substantial WTW GHG savings can be unlocked** (up to c.90%)
- But **in the wrong applications** and with higher-carbon fuel production pathways, **WTW GHG emissions can be no better or even higher** than the diesel comparators
- They all have exhaust emissions and may only have **limited complementary air quality benefits over and above the already very effective Euro VI systems**. Generally any such benefits are quite modest relative to Euro VI diesel vehicle emissions and savings in some areas (e.g. NOx) are often accompanied by increases in others (e.g. particulates)
- In this category, we place the **range-extended electric HGV, the dedicated CNG and LNG gas-powered vehicles and the dual fuel vehicles (LNG-diesel and hydrogen-diesel)**

#### Evolution Technologies

- Can be **applied to conventional, diesel-fuelled vehicles to help make small (but not insignificant) savings in diesel fuel consumption** (up to 10% or so), with consequentially similar savings in energy use and WTW GHG emissions. Logistical efficiency savings through reduced trips could also be achieved
- They will have **little or no direct air quality benefits** over and above Euro VI/6 diesel vehicles
- In this category, we place the **KERS trailer and various combinations of aerodynamic and/or lightweight trailers**

# Executive Summary

## List of technologies trialled

The LEFT programme covered thirteen separate combinations of vehicle type and technology, including vans, HGVs, refuse collection vehicles and road sweepers. In all, over 130 vehicles took part, across a dozen or more commercial fleets

LEFT vehicle type	N-category	Short- name	Lab tested	Fleet trialled	No. fleets
<b>Compressed Natural Gas (CNG) fuelled HGV- SI</b>	N3	CNG HGV	2	59	4
<b>Liquefied Natural Gas (LNG) fuelled HGV-SI</b>	N3	LNG HGV	1	4	1
<b>LNG-diesel dual-fuelled HGV-CI (using small quantity of diesel for ignition)</b>	N3	DF LNG	1	2	1
<b>Hydrogen-diesel dual-fuelled HGV-CI</b>	N2	DFH HGV	1	4	2
<b>Hydrogen-diesel dual-fuelled van-CI</b>	N1	DFH VAN	2	1	1
<b>Hydrogen-diesel dual-fuelled Refuse Collection Vehicle (RCV)-CI</b>	N3	DFH RCV	2	4	2
<b>Hydrogen-diesel dual-fuelled road sweeper-CI</b>	N3	DFH SWP	-	1	1
<b>Battery electric HGV</b>	N2	BE HGV	1	17	1
<b>Battery electric van</b>	N1	BE VAN	1	26	1
<b>Range-extended electric HGV (diesel range-extender engine)</b>	N2	REE HGV	1	14	1
<b>Diesel HGV with Kinetic Energy Recovery System (KERS) on semi-trailer</b>	N3	KERS-T	1	3	1
<b>Diesel HGV with Aerodynamic semi-trailer</b>	N3	AERO-T	1	2	1
<b>Diesel HGV with “Lightweight” semi-trailer (2t savings simulated in tests)</b>	N3	LTWT-T(2t)	1	-	

### Notes:

- The road sweeper (DFH SWP) was not lab tested as there is not yet a recognized standard test process for such vehicles and there was not scope in the LEFT programme to develop one
- Where more than one example of the same technology was lab tested (CNG HGV, DFH VAN and DFH RCV), the test programme included assessments of alternative manufacturer offerings of that technology or applications to different vehicle makes and/or retrofits to both Euro V and Euro VI vehicles
- N categories: N1 - Vans up to 3.5t gross weight, N2 – HGVs up to 12t, N3 HGVs > 12t

# Executive Summary

## Fuel/energy use (from the emissions testing programme)

The BEV and REEV achieved significant energy efficiency improvements across all cycles and most of the other technologies achieved small improvements in at least one. The dedicated gas vehicles minimised efficiency losses under long haul conditions

Fig ES1. Energy consumption of LEFT vehicles vs Diesel comparators, best to worst ranges, % savings or increases (best cycle indicated)

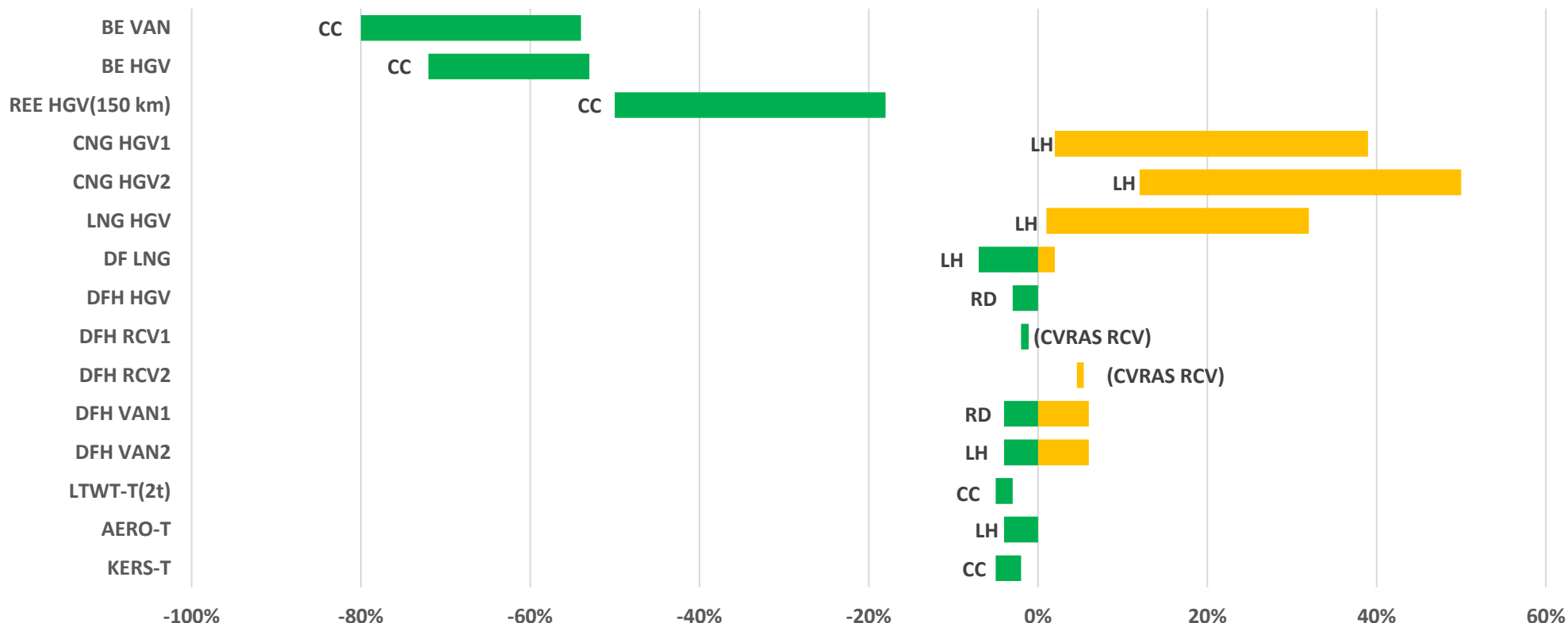

**Notes:**

- The RCVs were tested on a single cycle (CVRAS RCV) which includes elements of dense urban and suburban waste collection and a transfer phase, but the results have not been split by individual phase
- Key to cycles: CC = City Centre cycle, RD = Regional delivery, LH = Long Haul, CVRAS RCV = Clean Vehicle Retrofit Accreditation Scheme test cycle for Refuse Collection Vehicles
- Green indicates LEFT vehicle used less energy than its diesel comparator, Orange indicates higher energy use. Energy calculations based on standard properties of fuel (kWh/kg). Electricity figures include allowance for charging losses
- REE HGV figures based on 150 km trips, assuming full depletion of charged battery (approx. 100 km range in EV mode depending on cycle). Energy savings reduce as trip distances increase (greater use of the RE engine)
- All results shown relate to tests at 60% of maximum payload (55% for LTWT-T with 2t weight saving compared to otherwise identical diesel vehicle at 60%)



All the technologies achieved tailpipe reductions in GHG emissions in all cycles except the dedicated gas vehicles, but even they had lower emissions under their best (high speed/long haul) conditions

Fig ES2. Tailpipe GHG emissions of LEFT vehicles vs diesel comparators, best to worst ranges, % savings or increases (best cycle indicated)

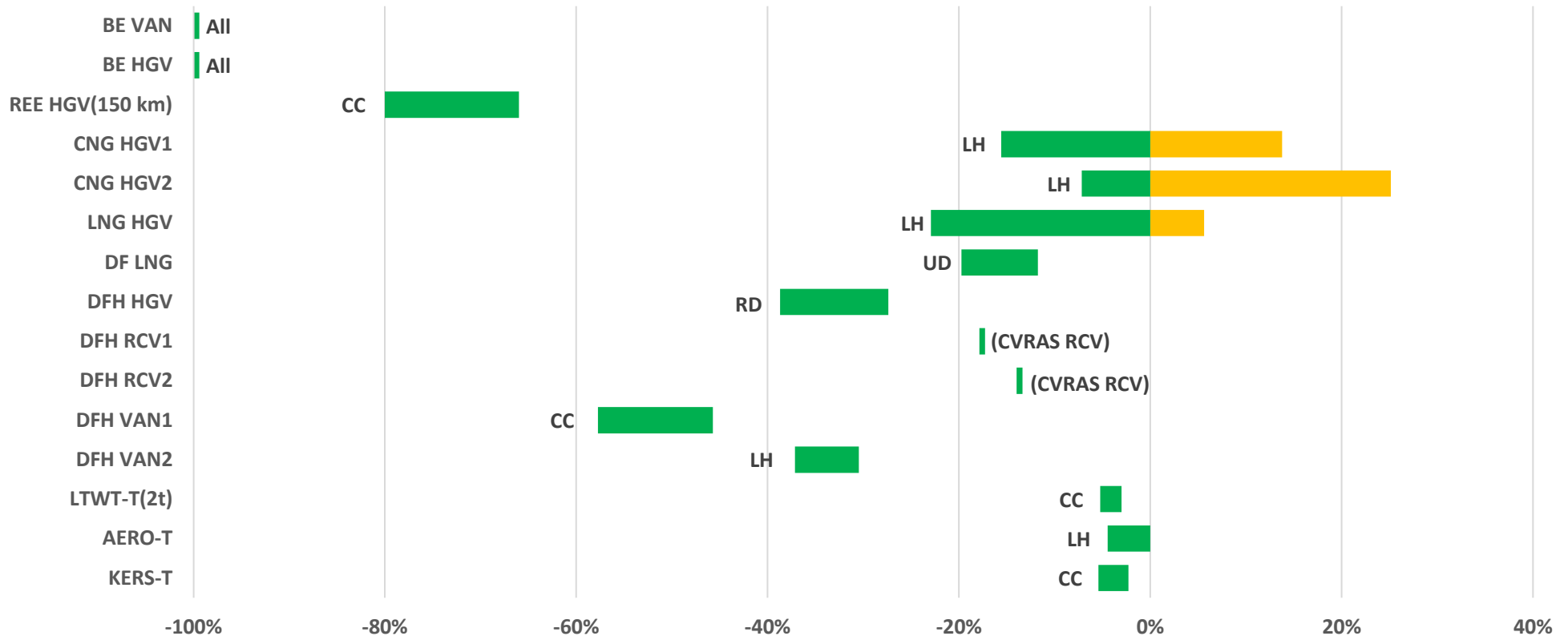

**Notes:**

- The RCVs were tested on a single cycle (CVRAS RCV) which includes elements of dense urban and suburban waste collection and a transfer phase, but the results have not been split by individual phase
- Key to cycles: CC = City Centre cycle, UD = Urban delivery, RD = Regional delivery, LH = Long Haul, CVRAS RCV = Clean Vehicle Retrofit Accreditation Scheme test cycle for Refuse Collection Vehicles
- Green indicates LEFT vehicle produced fewer emissions than its diesel comparator, Orange indicates higher emissions. All tailpipe CO2 treated as GHG (bio-content of fuels ignored)
- REE HGV figures based on 150 km trips, assuming full depletion of charged battery (approx. 100 km range in EV mode depending on cycle). GHG savings reduce as trip distances increase (greater use of the RE engine)
- All results shown relate to tests at 60% of maximum payload (55% for LTWT-T with 2t weight saving compared to otherwise identical diesel vehicle at 60%)



Additional WTW GHG savings can be achieved by using renewable fuels or electricity. GHG savings would be greatly reduced or in some cases eliminated completely if the fuels used are largely fossil-derived

Fig ES3. Well-to-Wheel (WTW) GHG emissions, best cycle (indicated), % savings or increases - range from using standard factors (right hand/red ends of bars) to renewable energy factors (left hand/green ends)

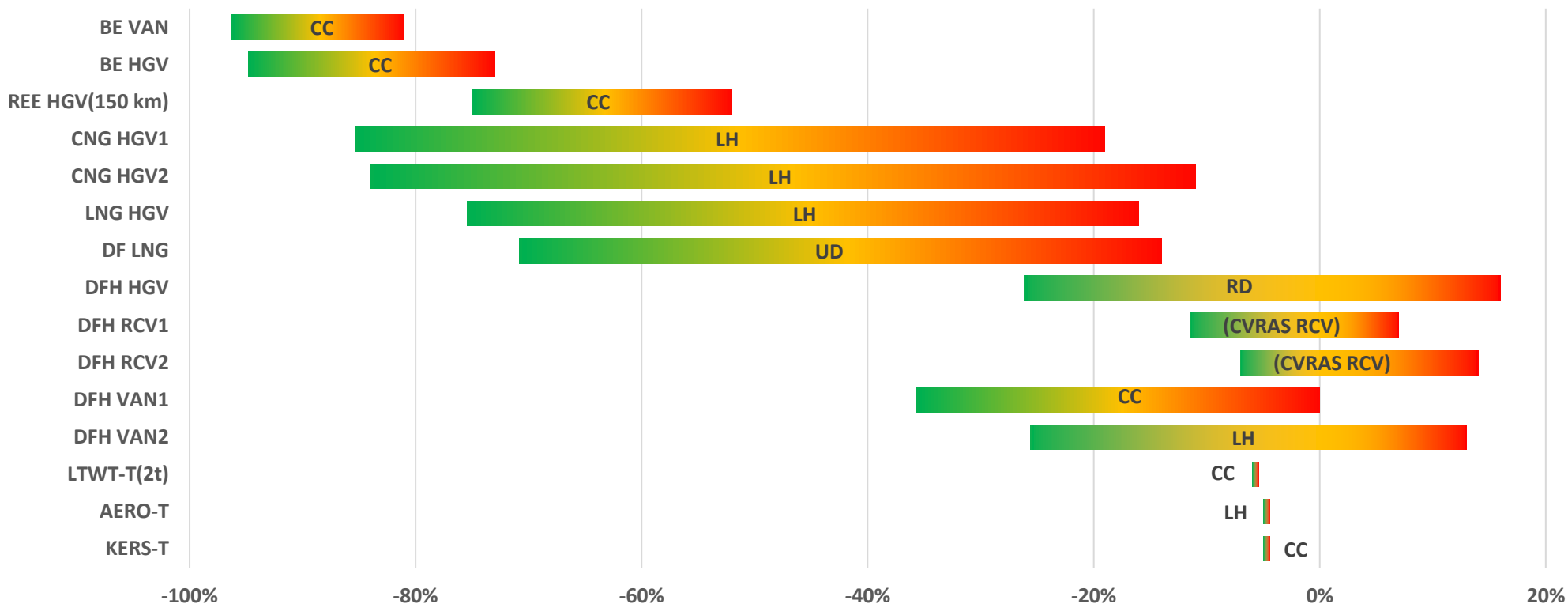

### Notes:

- Tailpipe CO<sub>2</sub> from non-fossil sources disregarded
- All "Standard" factors relate to Defra GHG reporting guidelines 2019 except hydrogen, which comes from a LowCVP analysis based on the most common UK industrial production pathway ("grey" hydrogen from natural gas)
- "Renewable Energy" factors also use official reporting figures from 2019 for biomethane, disregarding Scope 2 emissions from electricity and if using on-site, grid connected electrolysis with 100% renewable electricity tariff for ("green") hydrogen. All diesel fuel factors are based on 2019 pump-average figures only, as alternatives to diesel fuel (e.g. HVO or high-blend biodiesel) were outside of LEFT scope
- **The renewable energy factors (green ends of shaded bars) are considered to be more appropriate reflections of current practice in the road transport sector, including by the LEFT projects, than the official, economy-wide standard factors**

# Executive Summary

## Pollutant emissions (from emissions testing)

Only the zero exhaust emission BEV technologies achieved across-the-board pollutant emission reductions. The other technologies tested achieved NO<sub>x</sub> and/or PN emissions reductions in at least one cycle, but increases in at least one other

LEFT Technology	Exhaust Emissions			
	NO <sub>x</sub>		Particulate Number (PN)	
	Best cycle	Worst cycle	Best cycle	Worst cycle
BE VAN	-100%, all cycles			
BE HGV	-100%, all cycles			
REE HGV(150 km)	CC	LH	Not modelled	
CNG HGV1	UD	LH	LH	UD
CNG HGV2	CC	LH	CC	UD
LNG HGV	LH	UD	RD	LH
DF LNG	CC	RD	CC	LH
DFH HGV	CC	LH	UD	CC
DFH RCV1	(CVRAS RCV)		(CVRAS RCV)	
DFH RCV2	(CVRAS RCV)		(CVRAS RCV)	
DFH VAN1	CC	UD	CC	UD
DFH VAN2	CC	RD	UD	CC
LTWT-T(2t)	Not measured			
AERO-T	Not measured			
KERS-T	RD	CC	CC	UD

### Key:

CC = City Centre, UD = Urban Delivery, RD = Regional Delivery, LH = Long Haul

Green-shade indicates emissions lower than diesel comparator

Grey-shade indicates performance within +/- 2% of diesel comparator

Orange-shade indicates emissions greater than diesel comparator

Note: The technologies tested were all at varying stages of technological development

All the trials reported some important commercial, environmental, technological and/or operational benefits from their involvement in LEFT and the trials have clearly helped to grow the UK market for low emission vehicles and fuels

**Revolution Technologies** - The BEV projects reported many benefits, including:

- Substantial (>60%) **reductions in vehicle running costs** vs diesel
- Operational effectiveness proven and **myths about EVs dispelled**, e.g. range anxiety
- **Smart charging infrastructure** achieved substantial further cost savings vs depot connection upgrades (c. 80%)
- Significant **expansion of BEV fleets** in progress, as result of LEFT project experiences, for use across UK

**Transition Technologies** - Outcomes of the range-extended EV, gas and dual-fuel hydrogen-diesel projects include:

- **Real-world validation** of operational expectations and next generation technology developments identified
- **Strong business case proven** for gas-powered vehicles using RTFO approved bio-methane, for long haul/regional operations
- Substantial **orders placed for new gas-powered vehicles** by LEFT participants, accompanied by planned **expansion in refuelling infrastructure and bio-methane supply** (now at least 80% of all gas for road transport)
- **Positive driver feedback**, e.g. based on perceived environmental improvements or lower noise levels
- **Hydrogen combustion** can be done efficiently in dual fuel applications to displace diesel fuel use
- More reliable, cost effective **hydrogen refuelling infrastructure** is needed, using renewably-sourced (“green”) hydrogen

**Evolution Technologies** - The aerodynamic/lightweight trailers and the KERS trailer projects achieved much lower in-service running than the other LEFT projects, but nevertheless still gained some valuable lessons, including:

- LEFT **coalesced industry partners**, encouraged **new data analysis methods** and **identified further research** needs

### Challenges identified

- For a variety of reasons, several projects were unable to provide robust, like-for-like comparative performance data, but:
  - The separate testing programme was delivered successfully and generated a wealth of data to fill these gaps
  - Results from trials that did collect good quality in-service fuel consumption data align well with the testing programme



## Executive Summary

- 1. Background, objectives, trial methodologies and technologies**
2. Revolution Technologies
  - Battery Electric Vehicles
3. Transition Technologies
  - ICE Range Extended Electric Vehicles
  - Spark Ignition Dedicated Gas Vehicles
  - Compression Ignition Gas-Diesel Dual Fuel Vehicles
  - Compression Ignition Hydrogen-Diesel Dual Fuel Vehicles
4. Evolution Technologies
  - Lightweight and Aerodynamic Trailers
  - Trailer Kinetic Energy Recovery System
5. Other LEFT Technologies
6. Summary of trial outcomes
7. Further reading and information

# Section 1. Background, objectives, trial methodologies and technologies

## Background to LEFT Programme

The UK's binding GHG reduction targets under the Climate Change Act dictate the rapid development and implementation of low emission technologies and fuels for the UK commercial vehicle, freight transport and logistics sectors

### UK GHG Emissions

- Transport accounts for around 34% of all UK Greenhouse Gas emissions and is the largest single sector
- Commercial vehicles (vans and HGVs) account for about a third (33%) of domestic transport emissions (see figure below)
- Emissions from commercial vehicles are rising in both absolute and relative terms
- This trend has to be halted and reversed for the road freight sector to make its contribution to the UK's binding 2050 GHG reduction targets (now 100%, "net zero", by 2050)
- Developing alternative fuels and clean vehicle technologies will be crucial to this decarbonisation effort

### UK Transport GHG emissions by mode, 1990 and 2018

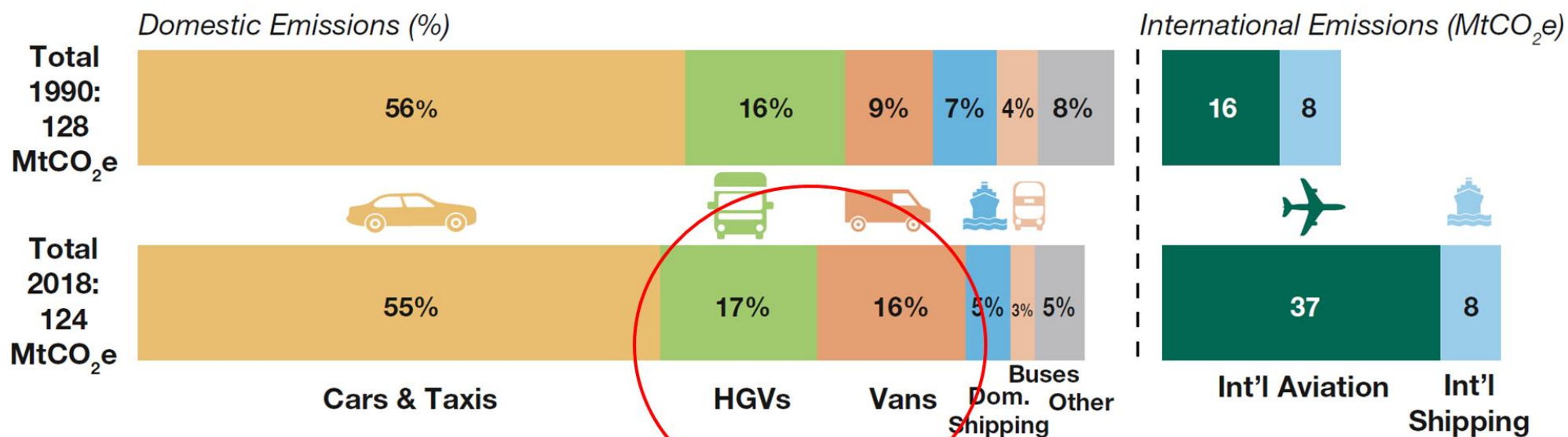

Source: 2018 UK greenhouse gas emissions<sup>12</sup>

**LEFT was a £20 million government funded programme which ran from 2017-20 that aimed to demonstrate the impacts of new technologies on both greenhouse gas and air quality pollutants to encourage the widespread introduction of low and zero emission vehicles to UK freight and other fleets**

### LEFT scope & objectives

- The aim of this competition was to trial, develop and demonstrate low emission vehicles in the freight, logistics, utilities and emergency industries. The ultimate aim was to speed up the adoption of low emission vehicles and fuels in these sectors
- The expected outcomes were that
  - Operators will have first-hand experience of low emission vehicles and fuels
  - They will be able to make informed decisions on future fleet mix in the short to medium term
- The competition was open to all technology areas and innovative methods of reducing emissions. The priorities were:
  - Technologies for zero tailpipe emissions, including range-extenders
  - Technologies achieving significant reduction of tailpipe CO<sub>2</sub>e or other emissions
  - Technologies achieving significant reduction of CO<sub>2</sub>e emissions on a Well-to-Wheel basis (i.e. including fuel/energy storage, production, processing and delivery)

### LEFT funding

- In 2017, the UK government awarded £20 million of grant funding to the Low Emission Freight & Logistics Trials (LEFT), supported by a further £12 million in private investment by trial participants
- The funding was delivered by the Office for Low Emission Vehicles (OLEV), with Innovate UK as the delivery partner
- OLEV is working across Government to support the market for ultra-low and zero emission vehicles
- By 2050, OLEV want almost every car and van in the UK to be zero emission and the technology needed to deliver that to be designed, developed and manufactured in the UK
- Since 2010, through Innovate UK, OLEV has provided R&D grants across the ultra-low and zero emission technology space, including on-vehicle technology (e.g. Integrated Delivery Programme & Niche Vehicle Network), pioneering charging infrastructure (e.g. Vehicle-to-Grid) and fleet trials (e.g. LEFT)
- OLEV are supporting freight decarbonisation in line with the aims of the Transport Decarbonisation Plan, through targeted R&D investment by identifying the best technological alternatives to enable Net Zero

Eight consortia projects were funded and their technologies' performance assessed via in-service trials and lab-based testing

### LEFT delivery

- Eight consortia received funding and completed the trials, involving various methane, hydrogen-diesel, battery and range-extended electric vehicles, aerodynamic and lightweight trailers and trailers with a Kinetic Energy Recovery System (KERS)
- Two independent methodologies were deployed: in-service monitoring and lab-based emissions testing to standard cycles
- TRL Ltd were appointed by Innovate UK to manage the test programme and to gather and analyse the in-service data
- LowCVP were separately tasked by Innovate UK to oversee and guide all technical aspects of the programme and to summarise its main findings (via two dissemination webinars held in July 2020 and production of this report)

### In-service monitoring

- In-service data was collected from the trial participants to compare the average fuel consumption of the LEFT vehicles with that of equivalent diesel baseline vehicles, alongside data on speeds, loads and distance to check for duty-cycle comparability
- In practice, only one project provided a fully reliable baseline because of vehicle availability and/or operational constraints
- Data on availability, reliability and maintenance were also collected and interviews undertaken with operators

### Emissions testing

- Each LEFT vehicle technology and its diesel comparator were tested on Millbrook's test track or their heavy-duty chassis dynamometer ('dyno'), normally at 60% of maximum permissible payload
- Vans and HGVs were tested to LowCVP-derived, industry-recognised duty cycles under tightly-controlled and repeatable conditions, covering the full range of typical operations: City Centre, Urban Delivery, Regional Delivery and Long Haul
- Refuse Collection Vehicles were tested to a LowCVP standard RCV cycle (on track), which includes bin-lifting and compaction
- All tests involved the measurement of fuel/energy consumed. For combustion-engine vehicles, exhaust greenhouse gas, pollutant and particulate emissions were also measured
- Tailpipe GHG measurements were combined with standard Well-to-Tank (WTT) factors for each fuel to estimate overall (Well-to-Wheel, WTW) emissions and the likely GHG-reduction potential of widespread adoption of each technology (using current UK government, economy-wide emission factors and those estimated for 100% renewable energy sources)



# Section 1. Background, objectives, trial methodologies and technologies

## Technologies trialled

The LEFT programme covered thirteen separate combinations of vehicle type and technology, which have been categorised as “Revolution”, “Transition” or “Evolution” technologies, reflecting their decarbonisation and air quality improvement potential

- The programme covered thirteen separate combinations of vehicle type and technology, including vans, HGVs, refuse collection vehicles and road sweepers
- Over 130 vehicles took part, across a dozen or more commercial fleets
- The technologies can each be placed into one of three broad categories; “Revolution”, “Transition” or “Evolution”, reflecting their decarbonisation and air quality improvement potential
- The following sections provide the main LEFT findings for each technology, using this general classification

LEFT vehicle type	N-category	Short- name	Lab tested	Fleet trialled	No. fleets
Compressed Natural Gas (CNG) fuelled HGV- SI	N3	CNG HGV	2	59	4
Liquefied Natural Gas (LNG) fuelled HGV-SI	N3	LNG HGV	1	4	1
LNG-diesel dual-fuelled HGV-CI (using small quantity of diesel for ignition)	N3	DF LNG	1	2	1
Hydrogen-diesel dual-fuelled HGV-CI	N2	DFH HGV	1	4	2
Hydrogen-diesel dual-fuelled van-CI	N1	DFH VAN	2	1	1
Hydrogen-diesel dual-fuelled Refuse Collection Vehicle (RCV)-CI	N3	DFH RCV	2	4	2
Hydrogen-diesel dual-fuelled road sweeper-CI	N3	DFH SWP	-	1	1
Battery electric HGV	N2	BE HGV	1	17	1
Battery electric van	N1	BE VAN	1	26	1
Range-extended electric HGV (diesel range-extender engine)	N2	REE HGV	1	14	1
Diesel HGV with Kinetic Energy Recovery System (KERS) on semi-trailer	N3	KERS-T	1	3	1
Diesel HGV with Aerodynamic semi-trailer	N3	AERO-T	1	2	1
Diesel HGV with “Lightweight” semi-trailer (2t savings simulated in tests)	N3	LTWT-T(2t)	1	-	

### Notes:

- SI = Spark Ignition, CI = Compression Ignition
- The road sweeper (DFH SWP) was not lab tested as there is not yet a recognized standard test process for such vehicles and there was not scope in the LEFT programme to develop one
- Where more than one example of the same technology was lab tested (CNG HGV, DFH VAN and DFH RCV), the test programme included assessments of alternative manufacturer offerings of that technology or applications to different vehicle makes and/or retrofits to both Euro V and Euro VI vehicles
- N categories: N1 - Vans up to 3.5t gross weight, N2 – HGVs up to 12t, N3 HGVs > 12t

# Section 1. Background, objectives, trial methodologies and technologies

## LEFT consortia

The eight completed LEFT projects engaged over thirty UK organisations, of all sizes and from the private, public and third sectors

- The eight projects that completed the LEFT programme are shown in the Table below
- Upwards of 30 organisations were directly involved, ranging from large multinationals and corporates to SME technology developers, universities and NGOs

Project Title	Lead Organisation	Partner Organisations	Technologies Trialed (short names)
Maximising CNG Benefits	CNG Fuels	John Lewis Partnership & University of Cambridge	CNG HGV
Dedicated To Gas	Air Liquide	Asda, Cenex, Emissions Analytics, Howard Tenens, Kuehne+Nagel & Microlise	CNG HGV, LNG HGV & DF LNG
Gnewt Cargo Commercial Electric Vehicle Trial	Gnewt Cargo (now Menzies Distribution)	Greater London Authority	BE VAN
Kinetic Energy Recovery for Urban Logistics Applications (KERS-URBAN)	Howdens	Alternatech, Imperial College & Sainsbury's	KERS-T
HyTime - Hydrogen Truck Implementation for Maximum Emission Reductions	Ulemco	Aberdeen City Council, Commercial, London Fire Brigade, Ocado, Veolia, Westminster City Council & Yorkshire Ambulance Service	DFH HGV, DFH VAN, DFH RCV & DFH SWP
Lightweight Aerodynamic Double-Deck Trailer Trial	Lawrence David	SDC Trailers, Tesco & University of Cambridge	AERO-T & LTWT-T(2t)
SEUL – Smart Electric Urban Logistics	UPS	Cross River Partnership, UK Power Networks & UK Power Networks Services	BE HGV
Zero Emission Capable Range Extended Electric UPS P80 Delivery Truck Retrofit Trial	Tevva Motors	UPS	REE HGV

## The following sections use a colour-coding scheme to help visualise LEFT vehicle performance compared to the Diesel baselines

- The following sections present detailed results tables from the emissions testing, alongside descriptions of the key findings from the in-service monitoring trials for each technology
- The figure below summarises the main test cycle abbreviations used throughout and the colour-coding scheme used to help visualise the performance of the LEFT vehicles against their Diesel comparators
- All Diesel comparator vehicles were Euro 6/VI unless otherwise indicated
- % changes are shown for energy and WTW GHG emissions only - % changes for pollutant tailpipe emissions can be highly misleading when using very low Euro 6/VI values as denominators so only absolute values are given for these
- Two WTW calculations are made, one using standard BEIS factors (2019), the other using renewable energy (RE) factors

### KEY to results tables:

Test Cycles - CC = City Centre, UD = Urban Delivery, RD = Regional Delivery, LH = Long Haul, CVRAS RCV = Clean Vehicle Retrofit Accreditation Scheme cycle for Refuse Collection Vehicles

Emissions – NO<sub>x</sub> = oxides of Nitrogen (NO and NO<sub>2</sub>), PN = Particle Number, CO = Carbon Monoxide, NMHC = Non-Methane Hydrocarbons

**-x%**

Green-shade indicates emissions/energy of LEFT vehicle lower than diesel comparator

**0%**

Grey-shade indicates performance within +/- 2% of diesel comparator (or pollutant emissions very similar in absolute terms)

**+x%**

Orange-shade indicates emissions/energy of LEFT vehicle greater than diesel comparator



## Executive Summary

1. Background, objectives, trial methodologies and technologies
- 2. Revolution Technologies**  
**Battery Electric Vehicles**
3. Transition Technologies
  - ICE Range Extended Electric Vehicles
  - Spark Ignition Dedicated Gas Vehicles
  - Compression Ignition Gas-Diesel Dual Fuel Vehicles
  - Compression Ignition Hydrogen-Diesel Dual Fuel Vehicles
4. Evolution Technologies
  - Lightweight and Aerodynamic Trailers
  - Trailer Kinetic Energy Recovery System
5. Other LEFT Technologies
6. Summary of trial outcomes
7. Further reading and information

## Section 2. Revolution technologies

### Battery-Electric Vehicles (testing and monitoring data)

**BEVs provide major savings in energy consumption, running costs, tailpipe and WTW GHG emissions, even using current pump/grid average factors (typically 50-80%) and have substantial air quality benefits (zero exhaust emissions)**

- Two LEFT projects trialled battery electric delivery vehicles, both for urban deliveries. The vehicles trialled were a 2t electric van modified with a roof extension to increase cargo capacity, a 3.5t van and a re-powered (Euro V) diesel 7.5t HGV
- In-service energy data was provided for at least 12 months for both LEFT vehicle types; 17 heavy vehicles and 26 light vans
- In both cases there were difficulties obtaining a full set of comparative diesel baseline data, either because the operator does not use diesel vehicles (all electric fleet) or data was only available from a limited time period
- Nonetheless the fleet trial results were fairly consistent with the Millbrook tests in the savings relative to the baseline
- There was an average saving of 64% in the cost per km (75% at best)
- A strong seasonal effect was observed with the energy consumption, especially for the heavy vehicles (24% higher in winter), consistent with the operator's experience of a 25% reduced range - cabin heating and frequent stops with the doors open
- Data from emissions tests shown in Table below:

Technology	Fuel/Energy			Greenhouse Gas Emissions (CO <sub>2</sub> e)			Pollutant Emissions (Diesel in brackets)		
Test cycle	Diesel l/100 km	LEFT kWh/km	Energy % change	LEFT Tailpipe g/km (Diesel in brackets)	WTW % change (BEIS factors)	WTW % change (RE factors)	NOx mg/km	PN #x10 <sup>11</sup> /km (whole cycle)	Other pollutants

#### BE VAN (60% payload)

Long Haul	7.2	0.33	-54%	0 (192)	-56%	-92%	0 (991)	0 (0.07)	0
Regional	6.9	0.28	-59%	0 (181)	-61%	-93%	0 (976)		0
Urban	6.2	0.18	-71%	0 (166)	-73%	-95%	0 (945)		0
City Centre	7.8	0.16	-80%	0 (210)	-81%	-96%	0 (787)		0

#### BE HGV (60% payload) – Euro V Diesel comparator used as baseline against the original vehicle before being re-powered as a BEV

Long Haul	12.7	0.59	-53%	0 (334)	-55%	-91%	0 (3380)	0 (360)	0
Regional	14.3	0.57	-60%	0 (377)	-61%	-93%	0 (3800)		0
Urban	16.7	0.55	-67%	0 (441)	-68%	-94%	0 (4430)		0
City Centre	22.1	0.62	-72%	0 (581)	-73%	-95%	0 (5780)		0

## Section 2. Revolution technologies

### Battery-Electric Vehicles (feedback from trial participants)

The BE VAN and BE HGV projects both reported significant wider operational benefits and the operators involved are now fully committed to accelerating their adoption of the technology

The two BEV projects reported many further benefits, including:

- Operational effectiveness proven and myths about EVs dispelled, e.g. range anxiety (in one of the trials, for example, on average, the vehicles arrived back at the depot with 62% charge remaining). Better driving experience
- Smart charging infrastructure achieved substantial cost savings vs depot connection upgrades (c. 80%) – integration of on-site battery energy storage, smart charging, network management and energy monitoring systems, plus reductions in peak loads
- Depot charging capacity for BE HGVs raised from 63 to 170 electric vehicles without conventional connection upgrade or major investment in third-party assets
- The Distribution Network Operator (DNO) used the BE HGV project to develop their distribution network planning toolkit and demonstrated it to other regional DNOs
- Significant expansion of BEV fleets progressing, as result of LEFT project experiences, for deployment across the UK
- Despite quite high vehicle purchase and infrastructure costs, overall operating costs were no higher than diesel equivalents
- The extra carrying capacity provided by the modified BE VAN allowed the trial vehicles to each deliver, on average, 30% more parcels per week than the unmodified EV fleet

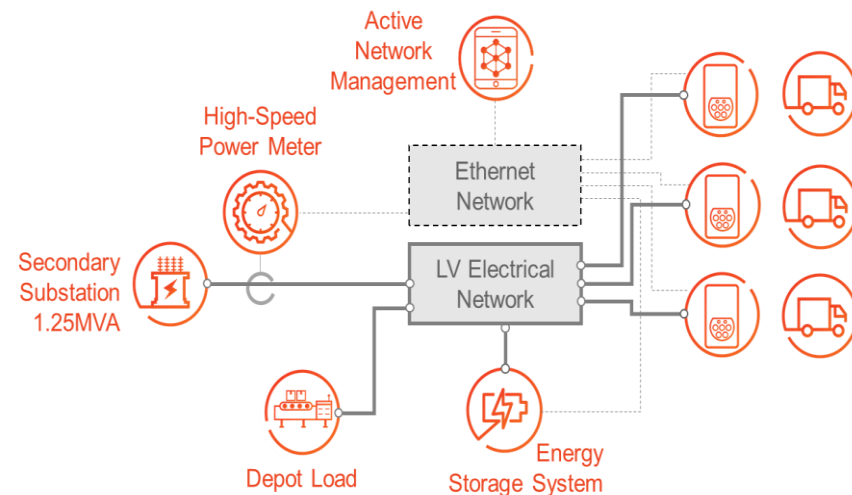



## Executive Summary

1. Background, objectives, trial methodologies and technologies
2. Revolution Technologies
  - Battery Electric Vehicles
3. **Transition Technologies**
  - ICE Range Extended Electric Vehicles**
  - Spark Ignition Dedicated Gas Vehicles**
  - Compression Ignition Gas-Diesel Dual Fuel Vehicles**
  - Compression Ignition Hydrogen-Diesel Dual Fuel Vehicles**
4. Evolution Technologies
  - Lightweight and Aerodynamic Trailers
  - Trailer Kinetic Energy Recovery System
5. Other LEFT Technologies
6. Summary of trial outcomes
7. Further reading and information



## Section 3. Transition technologies

### Internal Combustion Engine Range-Extended EVs (testing and monitoring data)

For trips of up to 250 km, when the engine is used sparingly, the REE HGV provided quite large savings in GHG emissions, but the low-tech diesel engine used in the trials produced high levels of pollutant emissions (relative to an equivalent Euro VI HGV)

- One project trialled 7.5t range-extended EVs for urban/suburban deliveries – mid-life Euro V HGVs re-powered with all-electric drives and fitted with small diesel engines working as electricity generators. The engines were not Euro certified but were, in broad terms at least, akin to Euro 5 diesel car engines, i.e. not fitted with a complex exhaust after-treatment system
- In-service fuel and electricity data were provided for a 12-month period during which the REEVs were introduced into service
- There were operational difficulties in obtaining a full set of comparative diesel baseline data
- Nonetheless the fleet trial results were fairly consistent with the Millbrook tests in the savings relative to the baseline
- Energy consumption was on average 43% lower than the baseline but increased in winter due to the use of cabin heating
- WTW CO<sub>2</sub>e emissions are highly dependent upon the proportion of total energy provided by diesel. On standard factors these were 38% lower than the baseline on average. Journeys typically 80 - 150 km per day, motorway/dense urban mix
- Data from emissions tests shown in Table below (using a Euro VI HGV as comparator, not the original Euro V pre-retrofit):

Technology	Fuel/Energy			Greenhouse Gas Emissions (CO <sub>2</sub> e)			Pollutant Emissions (Diesel in brackets)		
	Diesel l/100 km	LEFT kWh/km electricity + l/100km diesel	Energy % change	LEFT Tailpipe g/km (Diesel in brackets)	WTW % change (BEIS factors)	WTW % change (RE factors)	NOx g/km	PN #x10 <sup>11</sup> /km (whole cycle)	Other pollutants
<b>REE HGV (60% payload) – for 150 km journeys (with full depletion of battery from 100% SOC at start)</b>									
Long Haul	11.2	0.53 + 4.0	-18%	105 (305)	-21%	-57%	0.52 (0.04)	0.32 (0.33)	CO, NMHC
Regional	12.3	0.53 + 3.4	-30%	89 (336)	-33%	-65%	0.49 (0.19)		CO, NMHC
Urban	13.9	0.53 + 2.6	-44%	68 (382)	-46%	-75%	0.44 (0.40)		CO, NMHC
City Centre	18.0	0.53 + 3.7	-50%	98 (492)	-52%	-75%	0.71 (0.98)		CO, NMHC
<b>REE HGV (60% payload) – for 250 km journeys (with full depletion of battery from 100% SOC at start)</b>									
Long Haul	11.2	0.32 + 8.2	-1%	218 (305)	-1%	-23%	1.08 (0.04)	0.57 (0.33)	CO, NMHC
Regional	12.3	0.32 + 7.7	-12%	203 (336)	-15%	-34%	1.12 (0.19)		CO, NMHC
Urban	13.9	0.32 + 7.0	-27%	187 (382)	-29%	-47%	1.21 (0.40)		CO, NMHC
City Centre	18.0	0.32 + 8.3	-37%	220 (492)	-39%	-52%	1.59 (0.98)		CO, NMHC

## Section 3. Transition technologies

### ICE Range-Extended Electric Vehicles (feedback from trial participants)

The REE HGV trial fully achieved its operational objectives to deploy zero-emission capable vehicles on routes that would be difficult for full BEV deployment, and the results have informed next generation technology development

The REE HGV project reported many further benefits, including:

- Vehicles capable of delivering the same duty cycle as base diesel vehicle
- Drivers love these vehicles; drivability is improved, noise, vibration and harshness (NVH) is improved and the ability to merge into traffic is improved. Drivers go from 1000+ gear shifts per day to none
- Geo-fencing optimised EV mode use and minimised pollution impacts, which were in any event reduced from the original Euro V specification (i.e. the pollution that would have been emitted had the vehicle not been converted mid-life to REEV)
- 80-100 km typical EV-mode range achieved
- Operational expectations for the vehicles have been validated, a common battery pack developed and a technology for the next generation of commercially viable EV and zero emission REEV commercial vehicles defined

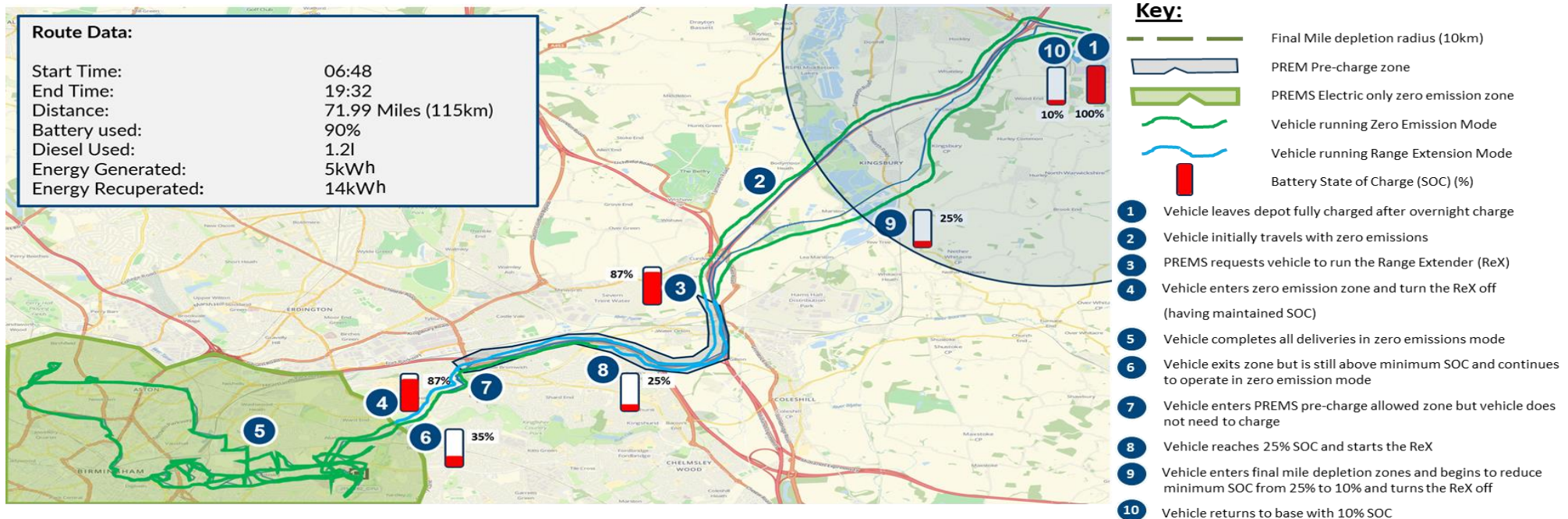

## Section 3. Transition technologies

### Spark Ignition Dedicated Gas Vehicles (testing and monitoring data)

Dedicated gas vehicles are best suited to long haul operations, where efficiency losses are minimised, and should be run on bio-methane for significant GHG savings to be achieved. Pollutant emissions are similar overall to comparable Euro VI Diesels

- Two projects trialed SI CNG or LNG HGVs over 12 months of the in-service trials. The trial vehicles consumed on average about 23-27% more energy than the Diesels, but by using RTFO certified bio-methane achieved 69-81% WTW GHG savings
- Based on standard factors (for fossil CNG/LNG), dedicated gas vehicles emit lower GHG emissions only in the higher speed cycles. At city/urban speeds, there are substantial energy efficiency penalties and both tailpipe and WTW emissions increase
- With bio-methane, testing indicates there would be substantial WTW savings on all cycles, in the range 67-85%
- Pollutant emissions performance is mixed, with overall no consistent benefit or penalty compared to Euro VI Diesels

Technology	Fuel/Energy			Greenhouse Gas Emissions (CO <sub>2</sub> e)			Pollutant Emissions (Diesel in brackets)		
Test cycle	Diesel l/100 km	LEFT kg/100km	Energy % change	LEFT Tailpipe g/km (Diesel in brackets)	WTW % change (BEIS factors)	WTW % change (RE factors)	NOx mg/km	PN #x10 <sup>11</sup> /km	Other pollutants
<b>CNG HG1 (31t gw, 60% payload)</b>									
Long Haul	26	21	+2%	574 (680)	-19%	-85%	695 (194)	1.4 (1.5)	CO
Regional	32	31	+22%	849 (837)	-3%	-82%	909 (256)	1.5 (0.7)	CO
Urban	44	43	+23%	1170 (1150)	-3%	-82%	859 (464)	3.7 (0.9)	CO
City Centre	55	61	+39%	1650 (1450)	+9%	-80%	1060 (388)	1.4 (1.3)	CO
<b>CNG HG2 (40t gw, 60% payload)</b>									
Long Haul	29	26	+12%	714 (769)	-11%	-84%	243 (5)	5.0 (2.4)	
Regional	37	38	+28%	1040 (980)	+2%	-82%	87 (10)	8.1 (4.2)	
Urban	48	50	+32%	1370 (1250)	+5%	-81%	158 (57)	21 (5.4)	
City Centre	58	69	+50%	1890 (1510)	+19%	-78%	218 (360)	16 (8.4)	
<b>LNG HG1 (40t gw, 60% payload, except City Centre tests which were only carried out on the dyno at 20t)</b>									
Long Haul	34	27	+1%	736 (955)	-16%	-75%	144 (309)	0.8 (2.2)	CO
Regional	45	39	+8%	1060 (1240)	-8%	-73%	285 (210)	0.4 (10)	CO
Urban	53	51	+23%	1400 (1420)	+6%	-69%	454 (325)	0.4 (2.7)	CO
City Centre	52	55	+32%	1500 (1420)	+14%	-67%	1370 (2750)	N/A	CO



## Section 3. Transition technologies

### Spark Ignition Dedicated Gas Vehicles (feedback from trial participants)

The SI gas vehicle trials achieved major growth in the use of RTFO certified bio-methane, have generated significant new investments in vehicles and refuelling infrastructure and have demonstrated a strong business case for operators

The CNG/LNG HGV projects reported many further benefits, including:

- First supply of bio-methane mass-balanced with LNG from Isle of Grain, now adopted by DfT as a standard
- Bio-methane supplied to trial trucks in all available forms: RTFO supply to CNG and LNG, Green Gas Certificates
- Telematics dashboard for alternative fuels developed, allowing greater visibility of vehicle performance
- Gas truck modelling tool developed - identifies routes with business case for deploying gas trucks and reduces operator risk
- Positive operational performance and driver feedback across the trials. Drivers perceived the gas trucks to be noticeably quieter and the refuelling process cleaner than with diesel
- Additional capital and maintenance costs in gas vehicles compared to diesel = pay back in 2 years at 160,000 km/year
- Methane slip not an issue for the gas trucks (confirmed by emissions testing, <2% tailpipe GHG impacts) or fuelling stations
- Trial participants have ordered over 200 more CNG/LNG trucks as result of positive LEFT experiences
- Bio-methane usage across the UK gas fuelling station network has increased, reaching 80% in 2019, and substantial investment is being made in developing a nationwide network of large public access bio-methane refuelling stations
- With the revised Renewable Energy Directive (RED 2) in 2021, where certain feedstocks can yield net-negative GHG emissions (avoided methane release), it will be possible to achieve greater than 100% GHG savings from running HGVs on bio-methane
- Gas vehicle reliability similar to the diesel comparators



## Section 3. Transition technologies

### Compression Ignition Gas-Diesel Dual Fuel Vehicles (testing and monitoring data)

The dual fuel LNG-diesel technology overcame the energy penalties otherwise associated with methane combustion, and even with fossil-based LNG achieved WTW GHG savings on all test cycles, but pollutant emissions tended to increase slightly

- One project trialled two DF LNG vehicles. These were powered mainly by liquefied methane but also combusted a small quantity of diesel fuel in a compression-ignition engine (used as the ignition source for the gas). They could not run on diesel or gas alone
- In-service data was collected for nine months, with some small differences in drive cycle apparent between the trial and diesel baseline vehicles but comparable energy consumption
- This technology overcomes the energy efficiency losses associated with SI dedicated gas vehicles, across all test cycles, and can generate modest WTW GHG emissions savings of around 8-14% if fossil-based LNG is used (with pump average diesel)
- The tailpipe GHG emissions savings were reduced by quite high levels of nitrous oxide production, particularly in the high speed cycles (up to 10% CO<sub>2</sub>e contribution over and above tailpipe CO<sub>2</sub> measured when dyno testing at 20t)
- With bio-methane, the WTW GHG savings can increase to 65% or more
- Pollutant emission control is evidently challenging, with notable increases seen in NOx, particulate and other emissions over the diesel comparator vehicle used in testing (but quantities measured still within the range of normal Euro VI values)

Technology	Fuel/Energy			Greenhouse Gas Emissions (CO <sub>2</sub> e)			Pollutant Emissions (Diesel in brackets)		
Test cycle	Diesel l/100 km	LEFT kg/100km + l/100km diesel	Energy % change	LEFT Tailpipe g/km (Diesel in brackets)	WTW % change (BEIS factors)	WTW % change (RE factors)	NOx mg/km	PN #x10 <sup>11</sup> /km	Other pollutants

#### DF LNG (44t gvw, 60% payload)

Long Haul	34	23 + 2	-7%	760 (914)	-13%	-66%	460 (189)	7.3 (0.7)	NMHC
Regional	45	31 + 3	-6%	993 (1200)	-13%	-67%	464 (118)	2.4 (0.6)	NMHC
Urban	59	43 + 3	-5%	1260 (1570)	-14%	-71%	1030 (428)	8.3 (3.8)	NMHC
City Centre	69	51 + 6	+2%	1580 (1790)	-8%	-65%	761 (551)	1.1 (1.0)	CO, NMHC

## Section 3. Transition technologies

### Compression Ignition Gas-Diesel DF Vehicles (feedback from trial participants)

The dual-fuel LNG-diesel trial generated similar benefits to the SI gas projects, in terms of bio-methane supply infrastructure development, and successfully conducted their own lab-based emissions tests to complement the standard Millbrook tests

The DF LNG project also trialled SI LNG HGVs and reported similar further benefits, including:

- First supply of bio-methane mass-balanced with LNG from Isle of Grain, now adopted by DfT as a standard
- Telematics dashboard for alternative fuels developed, allowing greater visibility of vehicle performance
- Gas truck modelling tool developed - identifies routes with business case for deploying gas trucks and reduces operator risk
- Positive operational performance and driver feedback across the trials.
- Additional capital and maintenance costs in gas vehicles compared to diesel = pay back in 2 years at 160,000 km/year
- Methane slip not an issue for the gas trucks (confirmed by emissions testing, <2% tailpipe GHG impacts) or fuelling stations
- Bio-methane usage across the UK gas fuelling station network has increased, reaching 80% in 2019, and substantial investment is being made in developing a nationwide network of large public access bio-methane refuelling stations
- Vehicle reliability similar to the diesel comparators, with gas substitution ratios of about 90% achieved – 40% typical payload
- The project also completed their own lab-based testing, at 100% payload, developing new testing protocols in the process (in line with LowCVP guidelines)



### LNG CI ARTIC

TCO savings gas vs diesel (£)					
Vehicle type: LNG CI Artic		Ownership period (years)			
		Annual distance (km)	3	5	7
Gas price (£/kg)	0.65	60,000	-£39,500 (-36%)	-£13,500 (-8%)	£7,400 (3%)
		120,000	-£6,900 (-4%)	£40,300 (14%)	£82,100 (21%)
		160,000	£14,500 (7%)	£75,800 (21%)	£131,500 (27%)
		200,000	£35,700 (14%)	£111,100 (26%)	£180,600 (31%)
	0.75	60,000	-£44,000 (-40%)	-£21,100 (-12%)	-£3,200 (-1%)
		120,000	-£16,000 (-9%)	£25,100 (9%)	£60,900 (16%)
		160,000	£2,400 (1%)	£55,600 (15%)	£103,200 (21%)
		200,000	£20,500 (8%)	£85,800 (20%)	£145,300 (25%)

The dual-fuel hydrogen-diesel vehicles consumed similar amounts of on-board energy to the same vehicles in diesel-only mode. Their GHG impacts depend on the specific hydrogen production method and diesel fuel displacement rate

- One project trialled various DF hydrogen vehicles. These modified, conventional diesel vehicles injected hydrogen into the engine to displace some (15-60%) of the diesel fuel. They could run on diesel only but not on 100% hydrogen
- Difficulties with hydrogen availability from public refuelling stations meant the level of operation in dual-fuel mode was much lower than was originally intended for many of the vehicles
- The proportion of km driven in dual-fuel mode as low as 4% in one case, but as high as 80% in another
- Fully independent trial and baseline fuel consumption data could not be obtained from the in-service trials so no quantitative comparisons could be made between the diesel only and dual-fuel operating modes
- When hydrogen was available, diesel displacements ranged from 10-46% during the in-service trials
- In testing, none of the vehicles showed any major energy penalties from injecting these quantities of hydrogen
- For the vans and HGVs tested, the hydrogen typically displaced 30-40% of the diesel fuel across the test cycles, though this was up to 60% with one vehicle (DFH VAN1, used as a technology-demonstrator vehicle)
- For the Refuse Collection Vehicles tested, displacements were 15-20%
- There were reductions in tailpipe GHG emissions (in line with diesel displacement rates), but using a WTT factor for the most common UK industrial hydrogen production route ('grey' Hydrogen), WTW GHG emissions would rise (by 10-30% typically)
- If hydrogen derived from electrolysis with renewable electricity is assumed ('green' hydrogen, as is more commonly the case for transport), WTW GHG savings of around 10-35% would be achieved
- In testing, NO<sub>x</sub> savings were achieved where they are most needed, in low speed, city-centre conditions but this was often accompanied by increased PN and/or CO emissions (all emissions though were within normal ranges for the Euro standard)
- Pollutant emission performance was very mixed in the other test cycles with no consistent or significant differences evident
- The full emissions testing results are provided in the table overleaf



## Section 3. Transition technologies

### CI Hydrogen-Diesel Dual Fuel Vehicles (emissions testing results)

Technology	Fuel/Energy			Greenhouse Gas Emissions (CO <sub>2</sub> e)*			Pollutant Emissions (Diesel in brackets)		
Test cycle	Diesel l/100 km	LEFT Kg H <sub>2</sub> /100km + Diesel l/100km	Energy % change	LEFT Tailpipe g/km (Diesel in brackets)	WTW % change (LowCVP/BEIS factors)	WTW % change (RE factors)	NOx mg/km	PN #x10 <sup>11</sup> /km	Other pollutants

#### DFH VAN1 (3.5t gvw, 60% payload)

Long Haul	Not tested								
Regional	10.7	1.3 + 5.8	-4%	152 (280)	+17%	-31%	953 (1120)	0.01 (0.06)	CO
Urban	9.0	1.2 + 4.7	-3%	122 (237)	+20%	-33%	1040 (1000)	0.03 (0.01)	CO
City Centre	11.4	2.2 + 4.8	+6%	126 (298)	+38%	-36%	319 (876)	0.00 (0.03)	CO

#### DFH VAN2 (3.5t gvw, 60% payload)

Long Haul	12.7	1.3 + 8.0	-4%	210 (334)	+13%	-26%	424 (368)	0.14 (0.04)	
Regional	11.5	1.3 + 7.7	+5%	202 (301)	+23%	-20%	451 (236)	0.07 (0.02)	
Urban	11.1	1.0 + 7.7	+1%	203 (291)	+17%	-19%	353 (419)	0.06 (0.02)	CO
City Centre	13.6	1.5 + 9.5	+6%	249 (358)	+24%	-18%	280 (428)	0.09 (0.01)	CO

#### DFH HGV (4.6t gvw, 60% payload)

Long Haul	9.3	1.0 + 5.8	-1%	153 (243)	+17%	-25%	856 (168)	0.13 (0.03)	CO
Regional	10.0	1.1 + 6.1	-3%	160 (261)	+16%	-26%	465 (271)	0.11 (0.02)	CO
Urban	10.8	0.9 + 7.9	-1%	207 (285)	+12%	-18%	264 (371)	0.09 (0.04)	CO
City Centre	14.2	1.4 + 9.5	0%	250 (372)	+16%	-22%	112 (746)	0.13 (0.01)	CO

#### DFH RCV1 (26t gvw, 60% payload, with bin-lifts and compactions)

CVRAS RCV	97	4.6 + 81	-1%	2110 (2550)	+7%	-11%	1040 (1830)	154 (39)	CO
-----------	----	----------	-----	-------------	-----	------	-------------	----------	----

#### DFH RCV2 (Euro V, 26t gvw, 60% payload, with bin-lifts and compactions)

CVRAS RCV	106	5.7 + 92	+5%	2400 (2770)	+14%	-7%	38,800 (42,400)	1970 (1770)	CO
-----------	-----	----------	-----	-------------	------	-----	-----------------	-------------	----

\* Note – There are no official factors for hydrogen. The factors used have been derived by LowCVP and are based on Steam Methane Reforming of Natural Gas, the economy-wide most common current industrial supply route for (“grey”) hydrogen and the use of renewable electricity for on-site electrolysis, using a grid connection and 100% RE tariff, a common supply route for (“green”) hydrogen in transport

## Section 3. Transition technologies

### CI Hydrogen-Diesel DF Vehicles (feedback from trial participants)

Despite reliability problems with public hydrogen refuelling infrastructure, the LEFT trials have helped to develop the dual-fuel hydrogen-diesel combustion technology and the vehicles fitted readily into a wide variety of existing fleet operations

The DF hydrogen project reported several further benefits, including:

- Data gathered in trials used to help inform technology development priorities
- Experience gained in procuring and installation of onsite refuelling facility
- 96% of the hydrogen used in the trial was from onsite (no transport related emissions) electrolysis with green tariff electricity (100% renewable)
- Operational cost is identified as the factor which has the most influence over the decision to uptake a low emission freight vehicle. For hydrogen dual fuel this comes down to the comparison of diesel price to hydrogen price
- Operators agreed that there was little difference in usability compared with diesel vehicles and commented it “fitted well with their daily operations” other than the need for daily fill and lack of reliability of the stations
- Results from the emissions tests have subsequently been used to implement changes in the system calibration, e.g. to achieve RCV diesel displacements of over 30% and to address the “rich burn” that caused the CO increases
- Drivers and operators are comfortable with using hydrogen in vehicles (safety issues did not feature as a barrier to using the technology) in particular integrating these into their usual fleet maintenance practices





## Executive Summary

1. Background, objectives, trial methodologies and technologies
2. Revolution Technologies
  - Battery Electric Vehicles
3. Transition Technologies
  - ICE Range Extended Electric Vehicles
  - Spark Ignition Dedicated Gas Vehicles
  - Compression Ignition Gas-Diesel Dual Fuel Vehicles
  - Compression Ignition Hydrogen-Diesel Dual Fuel Vehicles
- 4. Evolution Technologies**
  - Lightweight and Aerodynamic Trailers**
  - Trailer Kinetic Energy Recovery System**
5. Other LEFT Technologies
6. Summary of trial outcomes
7. Further reading and information

## Section 4. Evolution technologies

### Lightweight and aerodynamic trailers (testing and monitoring data)

**Aerodynamic trailer improvements reduced fuel and emissions by up to 5% and a 2 tonne weight reduction achieved 3-6%**

- For the in-service trial, two aerodynamic double-deck trailers were used (in a tractor-trailer combination of 44 tonnes GVW)
- These had optimised aerodynamic features at the front and rear of the trailer, on the side skirting, underbody and bumper
- A lightweight trailer was also under development, but not available during the trials. Its projected 2 tonne weight reduction was simulated at Millbrook by reducing the test load, giving fuel and WTW GHG savings of 3-6%, reducing as speed increases
- The in-service trial provided fuel usage data for a period of just five months, though with generally good comparability in operations between the LEFT and baseline vehicles achieved
- With this limited data set, however, a simple analysis of the average fuel consumed during the trials was not able to detect any effect of the aerodynamic features on fuel consumption
- More detailed analysis of the data was undertaken by Cambridge University, investigating the individual effects of speed, loading and distance on fuel consumption for individual trips. This found a statistically significant reduction in fuel consumption of over 2% using the aerodynamic trailer, when trips with average speeds lower than 55 km/h were excluded
- The fuel savings were shown to increase with speed, consistent with what would be expected for aerodynamic improvements and consistent with the emissions test results

Technology	Fuel/Energy			Greenhouse Gas Emissions (CO <sub>2</sub> e)			Pollutant Emissions (Diesel in brackets)		
	Diesel l/100 km	LEFT l/100km diesel	Energy % change	LEFT Tailpipe g/km (Diesel in brackets)	WTW % change (BEIS factors)	WTW % change (RE factors)	NOx g/km	PN #x10 <sup>11</sup> /km	Other pollutants
<b>LTWT-T(2t) (44t gvww, 60% payload – light-weighting simulated by removing 2 tonnes payload from the aero trailer)</b>									
Long Haul	30.4	29.5	-3%	773 (797)	-3%	N/A (diesel fuel only)	Not measured (unlikely to be affected)		
Regional	40.2	38.9	-3%	1020 (1060)	-4%				
Urban	56.8	53.8	-5%	1410 (1490)	-5%				
City Centre	72.6	69.0	-5%	1810 (1910)	-6%				
<b>AERO-T (44t gvww, 60% payload)</b>									
Long Haul	31.8	30.4	-4%	797 (834)	-5%	N/A (diesel fuel only)	Not measured (unlikely to be affected)		
Regional	41.3	40.2	-3%	1060 (1080)	-2%				
Urban	56.9	56.8	0%	1490 (1490)	0%				
City Centre	72.9	72.6	0%	1910 (1910)	0%				

## Section 4. Evolution technologies

### Lightweight and aerodynamic trailers (feedback from trial participants)

The LEFT project inspired new approaches to in-service trial data analysis, assisted the development of efficiency-enhancing weight reduction technologies and informed future vehicle fuel/energy simulation modelling

The LEFT project reported several further benefits, including:

- The weight saving technology, when developed fully, will allow additional payload to be carried if the trailer otherwise operates at or near full load, providing significant potential logistical efficiency/productivity benefits
- The LEFT trial coalesced the project, encouraged industry partners and demonstrated a new trial data analysis method
- The consortium also carried out its own detailed lab-based testing, including coast-down tests to precisely quantify the improvements in aerodynamic drag coefficient
- They also used the data generated to develop a comprehensive vehicle fuel efficiency simulation model, correlated against the results from all the lab-based testing

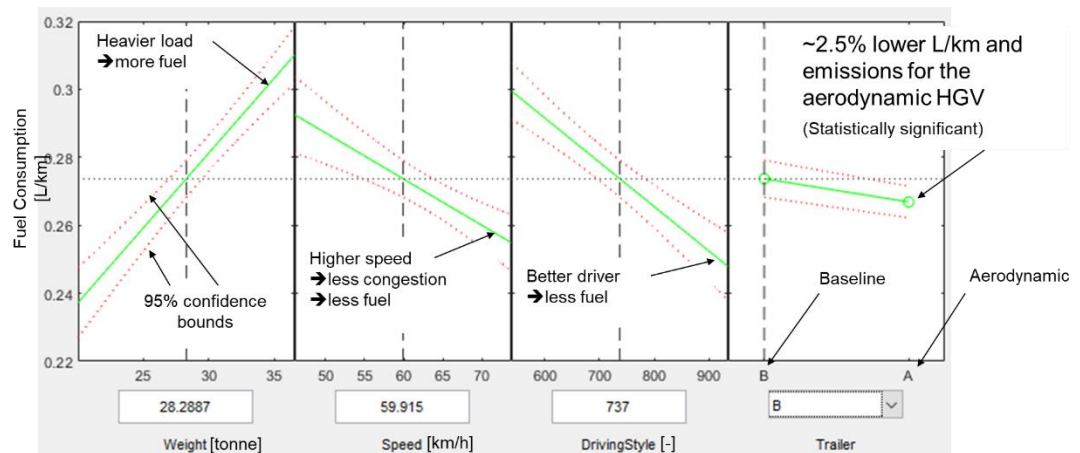
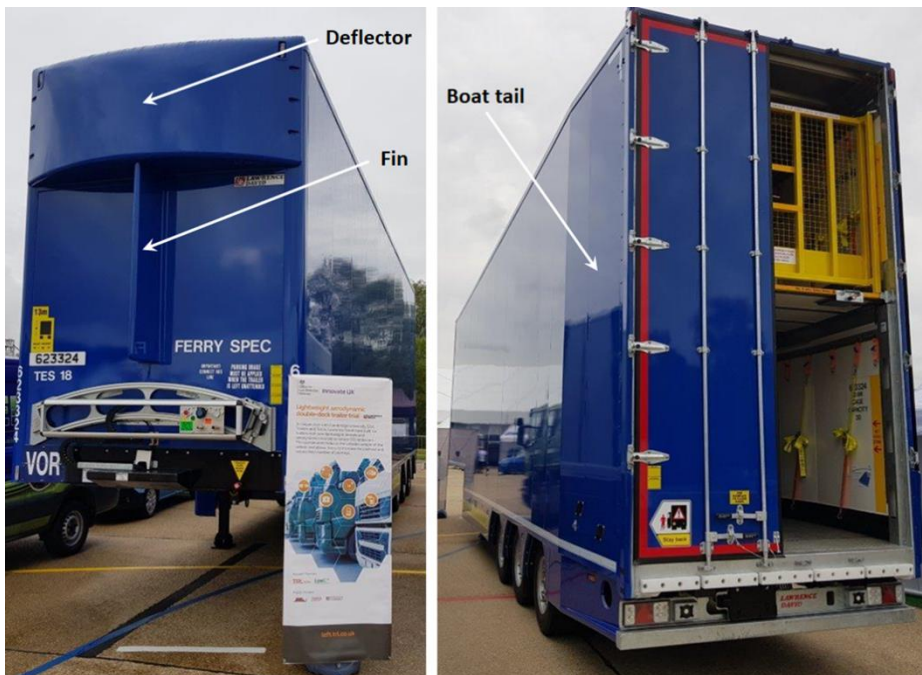



## Section 4. Evolution technologies

### Kinetic Energy Recovery System trailer (testing and monitoring data)

The KERS urban trailer project identified and overcame many technical challenges and the technology has the potential to reduce fuel use and emissions by up to 15% in the right urban/city operations and if equipped vehicles are driven optimally

- Three articulated ‘urban’ trailers (GVW 37.5 tonnes) were equipped with an energy recovery system in which an electrical generator/motor is installed on one of the axles
- Ultra-capacitors capture energy during braking and this is used to provide additional torque (to the same trailer axle) when the vehicle speeds up again
- It had originally been intended to equip a rigid vehicle as well, however this was not available for the trial due to unforeseen technical challenges
- Similar technical challenges with the trailer system severely restricted the time available to gather comparative data during the in-service trials, to less than three months
- Furthermore, the vehicles were frequently used in relatively high average speed applications where system effectiveness would be expected to be much lower than in highly transient, low speed city/urban type conditions (and at higher loads)
- Given the small sample size, and the differences observed between how the LEFT and baseline vehicles were used, it was concluded that reliable quantitative comparison of fuel consumption could not be made using the fleet trial data
- The lab-based tests showed small but measurable fuel and GHG savings, especially in the most transient, city centre cycle
- The testing also indicated that varying driving style (to maximise energy recovery) could increase savings to perhaps 10-15%
- No consistent effect on pollutant emissions was detected, unsurprisingly given the small changes in fuel consumption

Technology	Fuel/Energy			Greenhouse Gas Emissions (CO <sub>2</sub> e)			Pollutant Emissions (Diesel in brackets)		
Test cycle	Diesel l/100 km	LEFT l/100km diesel	Energy % change	LEFT Tailpipe g/km (Diesel in brackets)	WTW % change (BEIS factors)	WTW % change (RE factors)	NOx g/km	PN #x10 <sup>11</sup> /km	Other pollutants
<b>KERS-T (38t gvww, 60% payload)</b>									
Long Haul	Not tested (little or no benefit likely)								
Regional	38.5	37.6	-2%	987 (1010)	-2%	N/A (diesel fuel only)	101 (181)	1.5 (1.4)	CO
Urban	48.6	47.6	-2%	1250 (1270)	-2%		225 (205)	2.0 (1.3)	CO
City Centre	63.4	60.0	-5%	1570 (1660)	-5%		655 (346)	0.3 (0.4)	

## Section 4. Evolution technologies

### Kinetic Energy Recovery System trailer (feedback from trial participants)

In hindsight, the KERS system was not fully mature enough for deployment in the in-service trials but LEFT involvement has identified various steps for future development of this technology and quantified its fuel/emissions reduction potential

The LEFT project reported several further benefits and learnings, including:

- The technology must be deployed on inner-city and city-centre drive cycles to realise any benefit
- It is easy to integrate into fleet operations, with no difference in fuel/infrastructure
- Positive driver feedback was generated
- Potential weak points in the safety of the KERS system were identified that need to be addressed in future development
- Training may be needed for anyone who could come into contact with the vehicle (maintenance staff, emergency services etc)
- Additional drag on the drivetrain reduces fuel efficiency on trunking sections, which also needs to be addressed
- Components of KERS needs to be selected for each application, application to 18 tonne rigids was not successful
- Retro-fitting a drive axle to a trailer was more challenging than expected, required special parts and drive axle tyres
- Fuel consumption benefits are lower than expected, lower costs required to benefit TCO
- The project would not have gone ahead at all without LEFT support. The Millbrook tests show that a benefit is possible, and have been used, along with the technology development process, to identify areas for improvement





## Executive Summary

1. Background, objectives, trial methodologies and technologies
2. Revolution Technologies
  - Battery Electric Vehicles
3. Transition Technologies
  - ICE Range Extended Electric Vehicles
  - Spark Ignition Dedicated Gas Vehicles
  - Compression Ignition Gas-Diesel Dual Fuel Vehicles
  - Compression Ignition Hydrogen-Diesel Dual Fuel Vehicles
4. Evolution Technologies
  - Lightweight and Aerodynamic Trailers
  - Trailer Kinetic Energy Recovery System
5. **Other LEFT Technologies**
6. Summary of trial outcomes
7. Further reading and information



## Section 5. Other LEFT technologies

### Other Stream 1 projects (full in-service trials envisaged)

Four further projects started LEFT but were unable for various reasons to complete the in-service trials or emissions testing

- As well as the eight completed projects described above, LEFT involved four more projects that received some funding
- Each began work but terminated before being able to complete the in-service trials or the technologies being made available for emissions testing
- These projects are described in the table below

Project Title	Original Project Summary	Type of technology
HYLIGHT – HYbrid Liquefied petroleum Gas tanker with magsplit	For this project, two 18t trucks will be trialled, demonstrating new Plug-in Hybrid Electric Vehicle powertrains	Hybrid
Reduced Emissions Logistics (Red-E-Log)	A trial of both dedicated gas and direct injection dual-fuel methane/diesel trucks. The trucks will refuel with liquid biomethane, which is derived from wastes and is a sustainable and renewable fuel	Gas and dual fuel
Combustion Efficient Euro 6 HGV Dual Fuel	The consortium will demonstrate 15 dual fuel (diesel/methane) road vehicles. Innovation is demonstrated in 3 main areas, 1) Engine Combustion control, 2) Computer based engine modelling and 3) new super efficient methane catalysts	Gas
TRIUMPH (Temperature-controlled Range-extenders & Integrated Urban Mapping of Pollution) Hotspots	An operator will operate four fully electric, two range extended electric and two liquid nitrogen-cooled refrigeration vehicles on temperature controlled transport routes	Electric

## Section 5. Other LEFT technologies

### Stream 2 projects (technology development projects only)

Seven other projects were funded in LEFT Stream 2 to develop innovative low emission technologies, six of which completed

- The LEFT funding also covered (via Stream 2) a set of technology research and development (R&D) projects to develop innovative and disruptive on-vehicle technology, off-vehicle systems or new business models
- These projects could be a combination of desk-based research and lab demonstration and were required to show a clear route to market
- The six completed Stream 2 projects are described in the table below

Project Title	Original Project Summary	Type of Technology	Participants
Integrated UK zero emission drivetrain for commercial vehicles	This project will develop an integrated zero emissions drivetrain for a light commercial van	Hydrogen fuel cell	Arcola Energy Ltd, Haydale Composite Solutions Ltd, Commercial Ltd
eRCV Repowered Electric Refuse Collection Vehicle	MagTec proposes to repower a diesel refuse collection vehicle with an electric drive train and electric actuators for its hydraulic systems	Electric	Magnetic Systems Technology Ltd, Royal Borough of Greenwich, DG Cities Ltd
TevvaDrive 3.0. Range Extended Electric Trucks with UK designed and build E-motors and batteries	The project will deliver two demonstration trucks using highly innovative electrical machines from Newcastle University and Nissan batteries. Activities, beyond this project are intended to put these components into production	Electric	Tevva Motors Limited, University of Newcastle, Motor Design Ltd
AFT – a novel low emission fuel enrichment technology for freight vehicles	The project will trial an on-vehicle system for enriching hydrocarbon fuels with hydrogen in a pressurised unit	Hydrogen	Advanced Fuel Technologies UK Limited, University of Bath, Shipton Mill Limited
Aerodynamic Configurator for Transport (ACT): reducing haulage sector drags, costs and emissions	The project will trial an Aerodynamic Configurator for Transport (ACT). HGV geometries submitted to ACT are assessed for aerodynamic efficiency under a range of real world conditions and drive cycles. Hauliers can deploy the most efficient configuration of truck/trailer to quickly benefit from reductions in fuel costs and emissions	Aerodynamic truck design	TotalSim Ltd, Dynamon Limited
Greenwave: Transforming Driving Behaviour for a more Efficient and Environmentally Friendly Fleet	This project will trial a smartphone application which uses traffic signal data to transform fleet driver behaviour, encouraging them through gamification to drive in a more efficient manner	Driver behaviour	Idox Software Ltd, Paragus Ltd, Amey Birmingham Highways Limited, Birmingham City Council



## Executive Summary

1. Background, objectives, trial methodologies and technologies
2. Revolution Technologies
  - Battery Electric Vehicles
3. Transition Technologies
  - ICE Range Extended Electric Vehicles
  - Spark Ignition Dedicated Gas Vehicles
  - Compression Ignition Gas-Diesel Dual Fuel Vehicles
  - Compression Ignition Hydrogen-Diesel Dual Fuel Vehicles
4. Evolution Technologies
  - Lightweight and Aerodynamic Trailers
  - Trailer Kinetic Energy Recovery System
5. Other LEFT Technologies
6. **Summary of trial outcomes**
7. Further reading and information

### LEFT background information

- The UK's binding GHG reduction targets under the Climate Change Act dictate the rapid development and implementation of low emission technologies and fuels for the UK commercial vehicle, freight transport and logistics sectors
- LEFT was a £20 million government funded programme which ran from 2017-20 that aimed to demonstrate the impacts of new technologies on both greenhouse gas and air quality pollutants to encourage the widespread introduction of low and zero emission vehicles to UK freight and other fleets
- Eight consortia projects were funded and their technologies' performance assessed via in-service trials and lab-based testing
- The eight LEFT projects engaged over thirty UK organisations, of all sizes and from the private, public and third sectors
- LEFT covered thirteen separate combinations of vehicle type and technology, which have been categorised as "Revolution", "Transition" or "Evolution" technologies, reflecting their decarbonisation and air quality improvement potential

### Revolution Technologies

- Battery Electric Vehicles (BEVs) provide major savings in energy consumption, running costs, tailpipe and WTW GHG emissions, even using current pump/grid average factors (typically 50-80%) and have substantial air quality benefits (zero exhaust emissions)
- The BE VAN and BE HGV projects both reported significant wider operational benefits and the operators involved are now fully committed to accelerating their adoption of the technology

### Transition Technologies

- For trips of up to 250 km, when the engine is used sparingly, the REE HGV provided quite large savings in GHG emissions, but the low-tech diesel engine used in the trials produced high levels of pollutant emissions (relative to an equivalent Euro VI HGV)
- The REE HGV trial fully achieved its operational objectives to deploy zero-emission capable vehicles on routes that would be difficult for full BEV deployment, and the results have informed next generation technology development
- Dedicated gas vehicles are best suited to long haul operations, where efficiency losses are minimised, and should be run on bio-methane for significant GHG savings to be achieved. Pollutant emissions are similar overall to comparable Euro VI Diesels

### Transition Technologies (continued)

- The spark ignition (SI) gas vehicle trials achieved major growth in the use of RTFO certified bio-methane, have generated significant new investments in vehicles and refuelling infrastructure and demonstrated a strong business case for operators
- The dual fuel LNG-diesel technology overcame the energy penalties otherwise associated with methane combustion, and even with fossil-based LNG achieved WTW GHG savings on all test cycles, but pollutant emissions tended to increase slightly
- The dual-fuel LNG-diesel trial generated similar benefits to the SI gas projects, in terms of bio-methane supply infrastructure development, and successfully conducted their own lab-based emissions tests to complement the standard Millbrook tests
- The dual-fuel hydrogen-diesel vehicles consumed similar amounts of on-board energy to the same vehicles in diesel-only mode. Their GHG impacts depend on the specific hydrogen production method and diesel fuel displacement rate
- Despite reliability problems with public hydrogen refuelling infrastructure, the LEFT trials have helped to develop the dual-fuel hydrogen-diesel combustion technology and the vehicles fitted readily into a wide variety of existing fleet operations

### Evolution Technologies

- Aerodynamic trailer improvements reduced fuel and emissions by up to 5% and a 2 tonne weight reduction achieved 3-6%
- The LEFT project inspired new approaches to in-service trial data analysis, assisted the development of efficiency-enhancing weight reduction technologies and informed future vehicle fuel/energy simulation modelling
- The KERS urban trailer project identified and overcame many technical challenges and the technology has the potential to reduce fuel use and emissions by up to 15% in the right urban/city operations and if equipped vehicles are driven optimally
- In hindsight, the KERS system was not fully mature enough for deployment in the in-service trials but LEFT involvement has identified various steps for future development of this technology and quantified its fuel/emissions reduction potential



## Executive Summary

1. Background, objectives, trial methodologies and technologies
2. Revolution Technologies
  - Battery Electric Vehicles
3. Transition Technologies
  - ICE Range Extended Electric Vehicles
  - Spark Ignition Dedicated Gas Vehicles
  - Compression Ignition Gas-Diesel Dual Fuel Vehicles
  - Compression Ignition Hydrogen-Diesel Dual Fuel Vehicles
4. Evolution Technologies
  - Lightweight and Aerodynamic Trailers
  - Trailer Kinetic Energy Recovery System
5. Other LEFT Technologies
6. Summary of key trial outcomes
- 7. Further reading and information**



### *Background info on the Low Emission Freight & Logistics Trial (LEFT):*

WINNERS	<a href="https://www.gov.uk/government/news/low-emission-freight-and-logistics-trial-competition-winners-announced">https://www.gov.uk/government/news/low-emission-freight-and-logistics-trial-competition-winners-announced</a>
STREAM 1 WINNERS	<a href="https://assets.publishing.service.gov.uk/government/uploads/system/uploads/attachment_data/file/641549/OLEV_Low_Emission_Freight_Demonstration_-_Stream_1_-_Competition_Results....pdf">https://assets.publishing.service.gov.uk/government/uploads/system/uploads/attachment_data/file/641549/OLEV_Low_Emission_Freight_Demonstration_-_Stream_1_-_Competition_Results....pdf</a>
STREAM 2 WINNERS	<a href="https://assets.publishing.service.gov.uk/government/uploads/system/uploads/attachment_data/file/641550/OLEV_Low_Emission_Freight_Demonstration_-_Stream_2_-_Competition_Results....pdf">https://assets.publishing.service.gov.uk/government/uploads/system/uploads/attachment_data/file/641550/OLEV_Low_Emission_Freight_Demonstration_-_Stream_2_-_Competition_Results....pdf</a>
SCOPE	<a href="https://www.gov.uk/government/publications/funding-competition-low-emission-freight-and-logistics-trial/competition-brief-low-emission-freight-and-logistics-trial">https://www.gov.uk/government/publications/funding-competition-low-emission-freight-and-logistics-trial/competition-brief-low-emission-freight-and-logistics-trial</a>

### *Links and references to additional trial reports, provided by the consortia:*

BEV Van Trial	<a href="http://www.london.gov.uk/EV-delivery-trial">www.london.gov.uk/EV-delivery-trial</a>
BE HGV Trial	<a href="https://crossriverpartnership.org/projects/smart-electric-urban-logistics/">https://crossriverpartnership.org/projects/smart-electric-urban-logistics/</a>
CNG Trial	Madhusudhanan, Anil K., Xiaoxiang Na, Adam Boies, and David Cebon. "Modelling and evaluation of a biomethane truck for transport performance and cost." <i>Transportation Research Part D: Transport and Environment</i> 87 (2020): 102530 <a href="https://doi.org/10.1016/j.trd.2020.102530">https://doi.org/10.1016/j.trd.2020.102530</a>
CNG/LNG Trial	<a href="https://www.cenex.co.uk/case-studies/dedicated-to-gas/">https://www.cenex.co.uk/case-studies/dedicated-to-gas/</a>



**This report is published by the Low Carbon Vehicle Partnership**

Low Carbon Vehicle Partnership  
3 Birdcage Walk,  
London,  
SW1H 9JJ

Tel: +44 (0)20 7304 6880

E-mail: [secretariat@lowcvp.org.uk](mailto:secretariat@lowcvp.org.uk)

With thanks to:



Office for Low Emission  
Vehicles



Innovate  
UK

